

LTE Industrial Router

ICR-2734

USER MANUAL



ADVANTECH

© 2023 Advantech Czech s.r.o. No part of this publication may be reproduced or transmitted in any form or by any means, electronic or mechanical, including photography, recording, or any information storage and retrieval system without written consent. Information in this manual is subject to change without notice, and does not represent a commitment on the part of Advantech.

Advantech Czech s.r.o. shall not be liable for incidental or consequential damages resulting from the furnishing, performance, or use of this manual.

All brand names used in this manual are the registered trademarks of their respective owners. The use of trademarks or other designations in this publication is for reference purposes only and does not constitute an endorsement by the trademark holder.

Used symbols



Danger – Information regarding user safety or potential damage to the router.



Attention – Problems that can arise in specific situations.



Information, notice – Useful tips or information of special interest.



Contents

1	Product Overview	2
1.1	Product Introduction	2
1.2	Product Usage Examples	3
1.3	Hardware Overview	5
1.4	Order Codes	6
1.5	Package Contents	7
1.6	Product Dimensions	9
1.7	Mounting Recommendations	11
1.8	DIN Rail Mounting	12
1.9	Product Label	13
2	Hardware Functionality	14
2.1	SIM Card Slots	14
2.2	Antennas	15
2.3	Ethernet Interfaces	15
2.4	Power Supply	16
2.5	Low Power Mode	17
2.6	USB Port	17
2.7	LED Status Indication	19
2.8	Reset Functions	20
3	First Use	21
3.1	Accessories Connection	21
3.2	Router Configuration	21
4	Technical Specifications	23
4.1	Basic Parameters	23
4.2	Standards and Regulations	24
4.3	Type Tests and Environmental Conditions	25
4.4	Parameters of Cellular Module	26
4.5	System Configuration	27
	Appendix A: Troubleshooting	28
	Appendix B: Customer Support	31
	Appendix C: Regulatory & Safety Information	32
	Appendix D: Related Documents	34

List of Figures

1	Access to the Internet from LAN	3
2	Backed up Access to the Internet	3
3	Using VPN Tunnel	4
4	Serial Gateway	4
5	Hardware Overview of the Router	5
6	Metal Box – Top, Side and Front View	9
7	Plastic Box – Top, Side and Front View	10
8	Position of the DIN Rail Clip	12
9	Removing Router from the DIN Rail	12
10	Label Example	13
11	SIM Cards Insertion	14
12	Ethernet Connector Pinout	15
13	Connection of Power Supply	16
14	Position of the Grounding Screw	16
15	USB Connector Pinout	18
16	Resetting the Router	20
17	Router’s Web Interface	22

List of Tables

1	Hardware Overview of the Router	6
2	Order Codes Overview	6
3	Contents of Package	7
4	Other Accessories	8
5	Ethernet Connector Pinout Description	15
6	Power Supply Pinout	16
7	USB Connector Pinout	18
8	LED Status Indication	19
9	Basic Parameters	23
10	Standards and Regulations	24
11	Type Tests and Environmental Conditions	25
12	Technical Parameters of Cellular Module	26
13	System Configuration	27

1. Product Overview

1.1 Product Introduction

Industrial cellular router ICR-2734 is designed for wireless communication in mobile networks that use traditional cellular technologies.

The primary purpose of this router is its use in the Category 4 (**Cat.4**) services on the cellular **LTE** network. Cat.4 rated router is capable of achieving typical speeds in 4G coverage areas where the network is enabled with 20 MHz of contiguous spectrum.

The peak **downlink** data rate for Category 4 is approximately **150 Mbps**. In the **uplink**, LTE Category 4 provides a peak data rate of **50 Mbps**.

The router, which may have a **metal** or **plastic** box, is equipped with two independently configurable **Ethernet ports**, two **Mini SIM slots** (2FF), main and diversity cellular **antenna connectors**, with one **USB 2.0** host interface and with **LEDs for status** indication.

The router provides **diagnostic functions**, which include automatically monitoring the PPP connection, automatic restart in case of connection losses, **Low Power Mode** and **hardware watchdog** that monitors the router status.

The router supports **VPN tunnel** creation using various protocols to ensure safe communications. The router provides diagnostic functions which include automatic monitoring of the wireless and wired connections, automatic restart in case of connection losses, and a hardware watchdog that monitors the router status.

With open Linux platform and wide possibilities of programming customer SW applications in **Python**, **C/C++**. The Advantech existing app library **Router Apps** (formerly *User modules*) with apps already developed to enhance specific router functionality including industrial protocol conversions and support of IoT platforms such as **MS Azure**, **Cumulocity**, **ThingWorx**, and others are supported on the router.

Examples of possible applications

- mobile office
- fleet management
- security system
- telematic
- telemetric
- remote monitoring
- vending and dispatcher machines

1.2 Product Usage Examples

The router is primarily intended for these four basic situations:

I. Access to the Internet from LAN

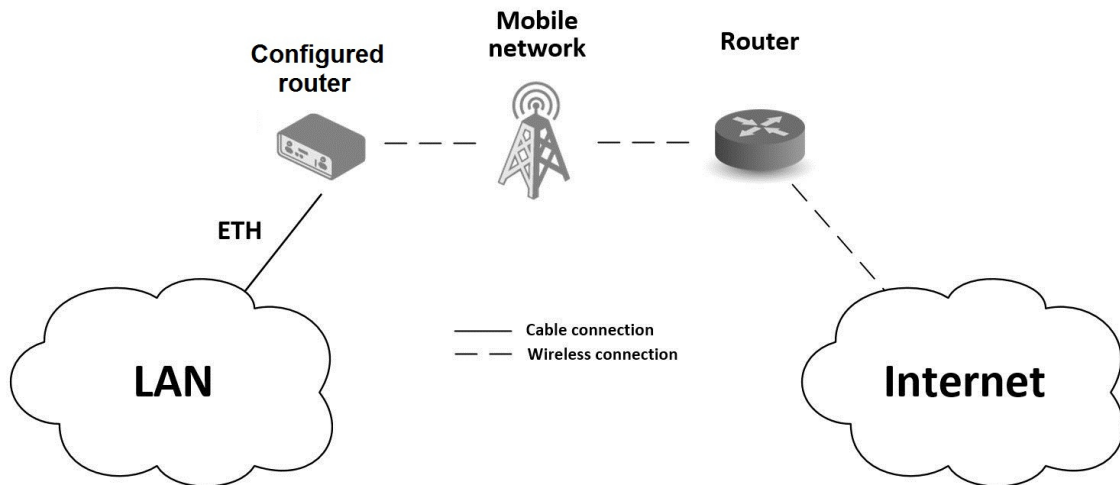

Figure 1: Access to the Internet from LAN

II. Backed up access to the Internet (from LAN)

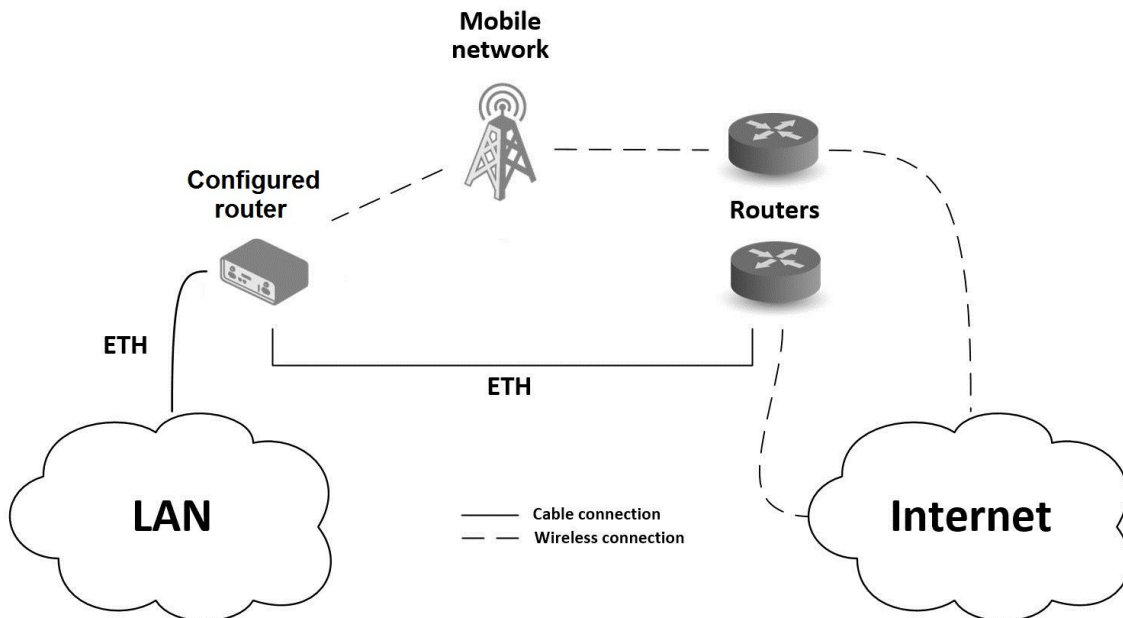

Figure 2: Backed up Access to the Internet

III. Secure networks interconnection or using VPN

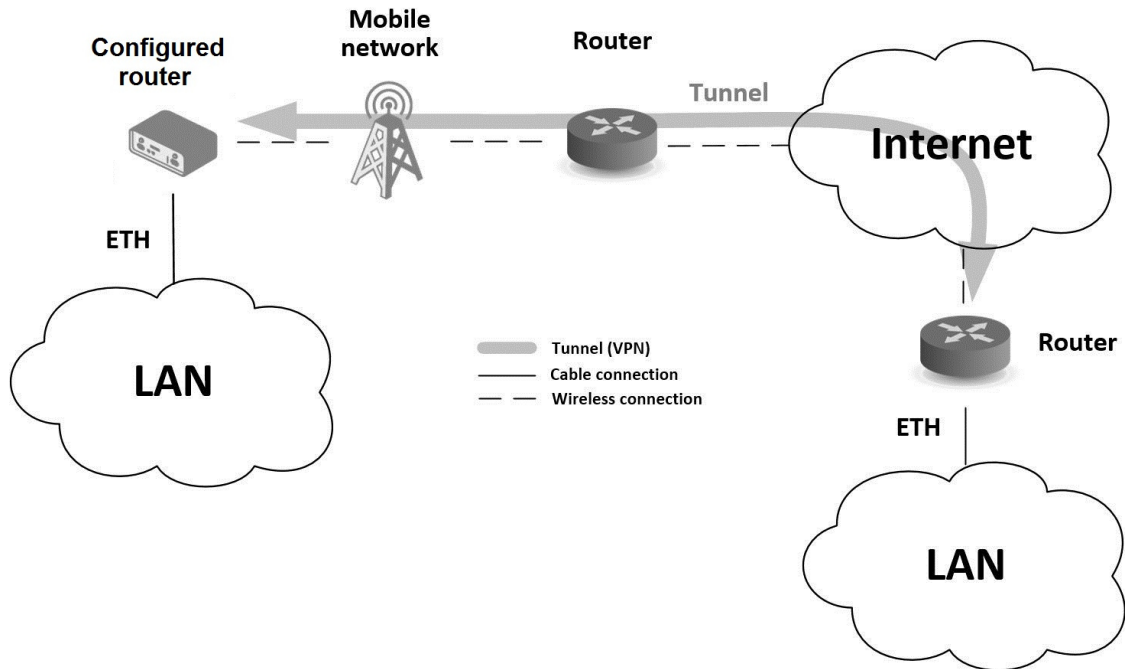

Figure 3: Using VPN Tunnel

IV. Serial Gateway

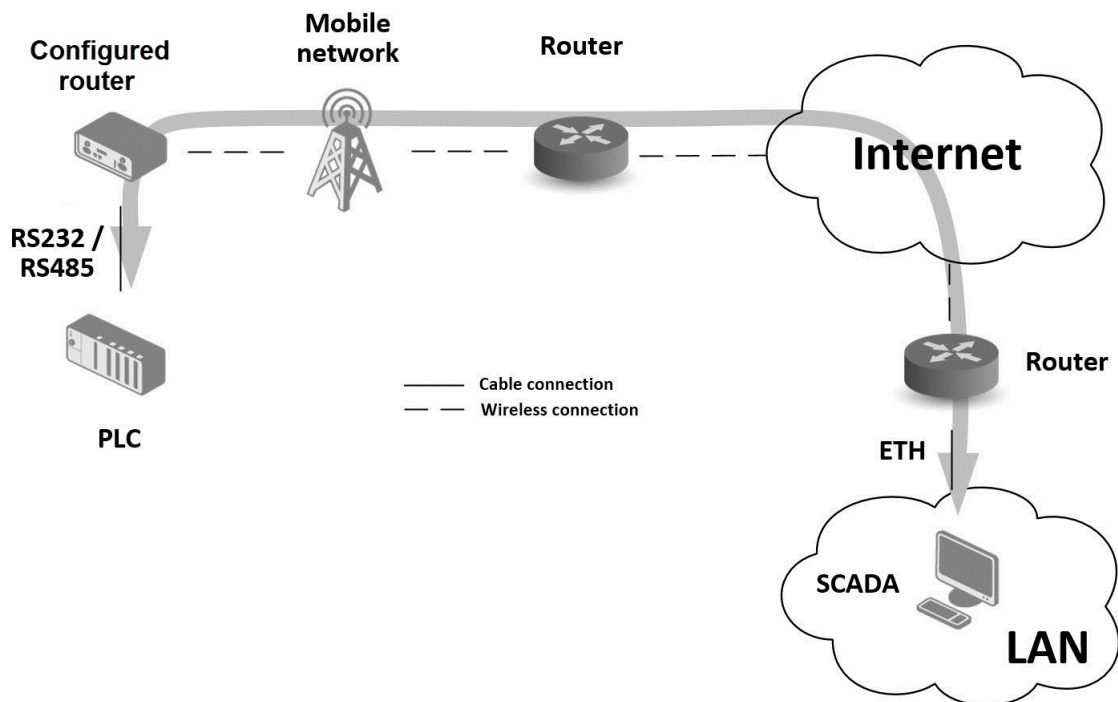

Figure 4: Serial Gateway

1.3 Hardware Overview

The router case preview is shown in Figure 5. A short description of hardware parts of the router is listed in Table 1, including the links to the chapters with a detailed description. For a router in a plastic box, the description of the components is similar.



Figure 5: Hardware Overview of the Router

#	Item/Caption	Type	Description
1	LEDs	-	Status LED indication; see Chapter 2.7.
2	SIM slots	Mini SIM	Two SIM card slots; see Chapter 2.1.
3	ANT	SMA	Connector for the first main antenna of the cellular module; see Chapter 2.2 and Chapter 4.4 for cellular module parameters.
4	DIV	SMA	Connector for the first diversity antenna of the cellular module; see Chapter 2.2 and Chapter 4.4 for cellular module parameters.
5	USB	USB-A	USB-A type socket connector; see Chapter 2.6.
6	ETH0, ETH1	RJ45	100 MB Ethernet connection for the first and second LAN; see Chapter 2.3.
7	PWR	2-pin terminal	Power supply socket; see Chapter 2.4.

Continued from previous page

#	Item/Caption	Type	Description
8	RST	-	Button to reboot the router or to restore the default configuration; see Chapter 2.8.
9	DIN clip	-	DIN rail clip, included as standard accessories; see Chapter 1.8.
10	Grounding screw	M3	Pay attention to proper grounding of model with metal box; see Chapter 2.4.

Table 1: Hardware Overview of the Router

1.4 Order Codes

Order codes overview is shown in the table below.

Order code	Configuration
ICR-2734	metal box, LTE Cat.4 with 3G/2G fallback module, ETH0, ETH1, USB, two SIM readers
ICR-2734P	plastic box , LTE Cat.4 with 3G/2G fallback module, ETH0, ETH1, USB, two SIM readers
ICR-2734A01	metal box, LTE Cat.4 with 3G/2G fallback module, ETH0, ETH1, USB, two SIM readers, accessories with Ethernet cable, two antennas, and EU power supply
ICR-2734PA01	plastic box , LTE Cat.4 with 3G/2G fallback module, ETH0, ETH1, USB, two SIM readers, accessories with Ethernet cable, two antennas, and EU power supply
ICR-2734A02	metal box, LTE Cat.4 with 3G/2G fallback module, ETH0, ETH1, USB, two SIM readers, accessories with Ethernet cable, two antennas, and UK power supply
ICR-2734PA02	plastic box , LTE Cat.4 with 3G/2G fallback module, ETH0, ETH1, USB, two SIM readers, accessories with Ethernet cable, two antennas, and UK power supply

Table 2: Order Codes Overview

1.5 Package Contents

The standard router set includes items listed in Table 3: For other optional accessories, see Table 4.





Item#	Description	Figure	Q'ty
1	Router in metal or plastic box		1 pcs
2	DIN rail clip with screws (screws differ for metal and plastic versions)		1 set
3	2-pin terminal block for power supply (deployed on the router)		1 pcs
4	Printed <i>Quick Start Guide Leaflet</i>		1 pcs

Table 3: Contents of Package

Table 4 lists items that may be included as accessories or can be ordered separately. See Chapter 1.4 for more information.





Description	Figure
Ethernet cross cable of length 1.5 m. It can be ordered separately under <i>BB-KD-ETH</i> part number.	
Antenna 5G/LTE. It can be ordered separately under <i>ANT-LTE5G-025</i> part number.	
Wall mount power supply, 12V/1A with EU plug. It can be ordered separately under <i>BB-RPS-v2-EU</i> part number.	
Wall mount power supply, 12V/1A with UK plug. It can be ordered separately under <i>BB-RPS-v2-UK</i> part number.	
Wall mount power supply, 12V/1A with US plug. It can be ordered separately under <i>BB-RPS-v2-US</i> part number.	

Table 4: Other Accessories

1.6 Product Dimensions

For the dimensions of the product in metal and plastic boxes see the figures below. Note that all sizes are measured in millimeters.

Variant with Metal Box

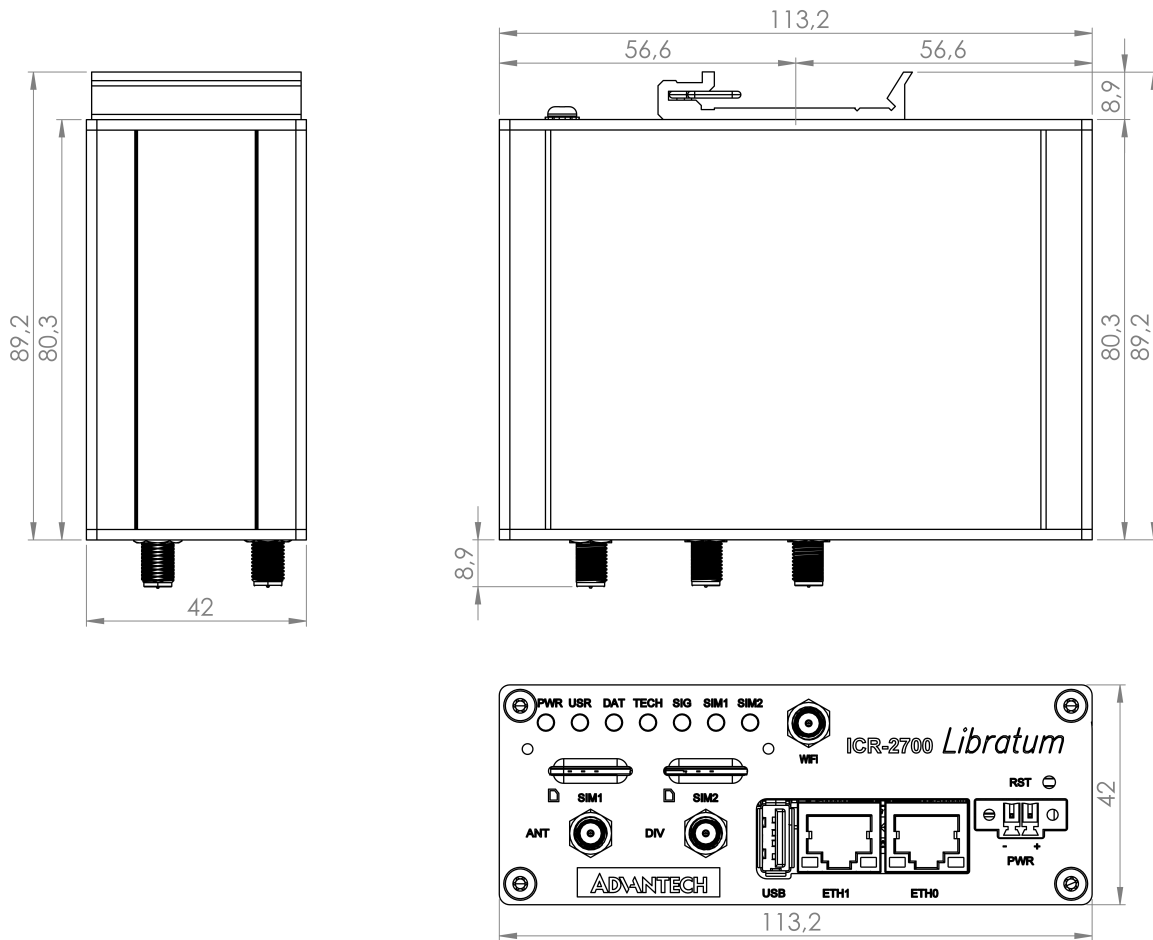

Figure 6: Metal Box – Top, Side and Front View

Variant with Plastic Box

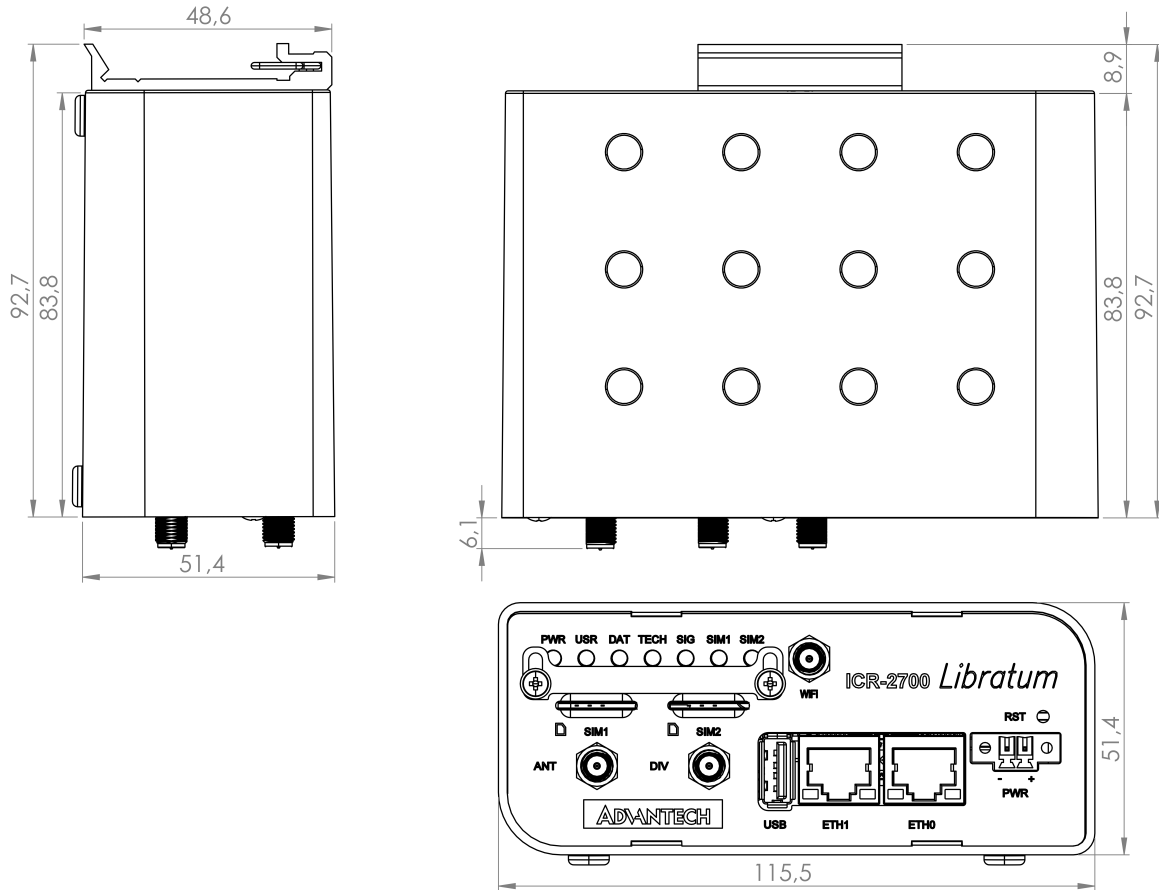

Figure 7: Plastic Box – Top, Side and Front View

1.7 Mounting Recommendations

The router can be placed:

- on a flat surface,
- on a DIN rail EN 60715 with the metal DIN rail clip (see Chapter 1.8)

For most applications with a built-in router within a switchboard, it is possible to recognize two kinds of environments:

- A non-public, industry environment of low voltage with high interference,
- a public environment of low voltage and without high interference.

For both of these environments, it is possible to mount the router to a switchboard, after which there is no need to have examination immunity or issues in connection with EMC according to EN 61439-1:2011.



In compliance with the EN 61439-1:2011 specification, it is necessary to observe the following assembly instructions for a router attached to a switchboard:

- For whip antennas it is recommended to observe a minimum distance of 6 cm from cables and metal surfaces on every side in order to avoid interference. When using an external antenna separate from the switchboard it is necessary to fit a lightning conductor.
- When mounting a router on sheet-steel we recommend using a cable antenna.
- For all cables, we recommend to bind the bunch, and for this we recommend:
 - The length of the bunch (the combination of power supply and data cables) should be a maximum 1.5 m. If the length of data cables exceeds 1.5 m or if the cable is leading towards the switchboard, we recommend installing surge protectors.
 - Data cables must not have a reticular tension of ~ 230 V/50 Hz or ~ 120 V/60 Hz.
- Sufficient space must be left between each connector for the handling of cables,
- To ensure the correct functioning of the router we recommend the use of an earth-bonding distribution frame for the grounding of the grounding screw, see Chapter 2.4.

1.8 DIN Rail Mounting

The DIN rail clip is suitable for a DIN rail according to EN 60715 standard only. There are four possible positions of the clip as shown in Figure 8.

i The DIN rail clip is the same for the metal and plastic router box. It just differs by the screws used.

! When mounting the DIN rail clip, tighten the screws with max. torque of 0.4 Nm.

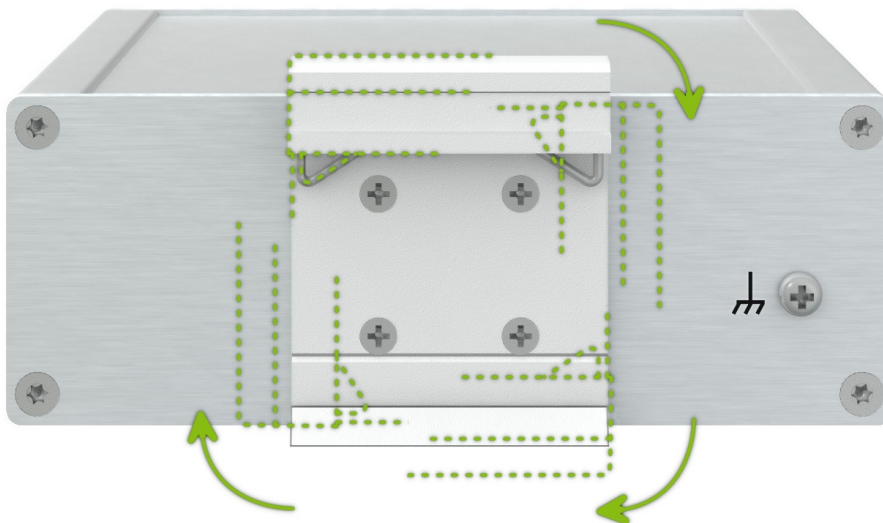

Figure 8: Position of the DIN Rail Clip

To remove the router from the DIN rail it is necessary to lightly push down the router so that the bottom part of the DIN rail clip hitched to the DIN rail get out of this rail and then fold out the bottom part of the router away from the DIN rail, see Figure 9.

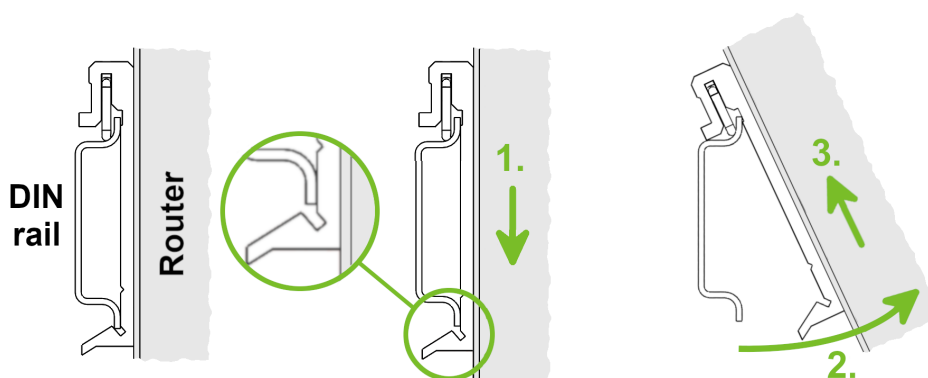

Figure 9: Removing Router from the DIN Rail

1.9 Product Label

An example of the product label, with all the information printed on it, is in the figure below.



Figure 10: Label Example

2. Hardware Functionality

See Chapter 1.3 for the product hardware overview. Table 1 lists a short description of the hardware, including the links to the chapters with a detailed description.

2.1 SIM Card Slots

Slots for two SIM cards are located on the router under a metal cover. If you intend to use this device to communicate over a cellular network, please place an activated data-provisioned SIM card into the SIM card reader.

You can install two SIM cards simultaneously to utilize the switching feature. The SIM cards may have different APNs (Access Point Names) adjusted. The SIM card changing procedure is described below. Enter the PIN in the router's web interface if the PIN is required for the SIM (*Administration -> Unlock SIM Card*).



Type of SIM card: Mini SIM (2FF) 25.0 x 15.0 x 0.76 mm.

Inserting the SIM card:



- Always disconnect the router from the power supply before handling the SIM card.
- Release two screws on the SIM card cover and swipe up the cover.
- To remove an inserted SIM card, use the flat end of a spudger, or your fingernail, press the SIM card slightly into its slot until you hear a click. After hearing this click, release the card, and it will pop out of its slot.
- To insert a SIM card push card into the slot until it clicks into place.
- Swipe down the cover and tight the cover screws.

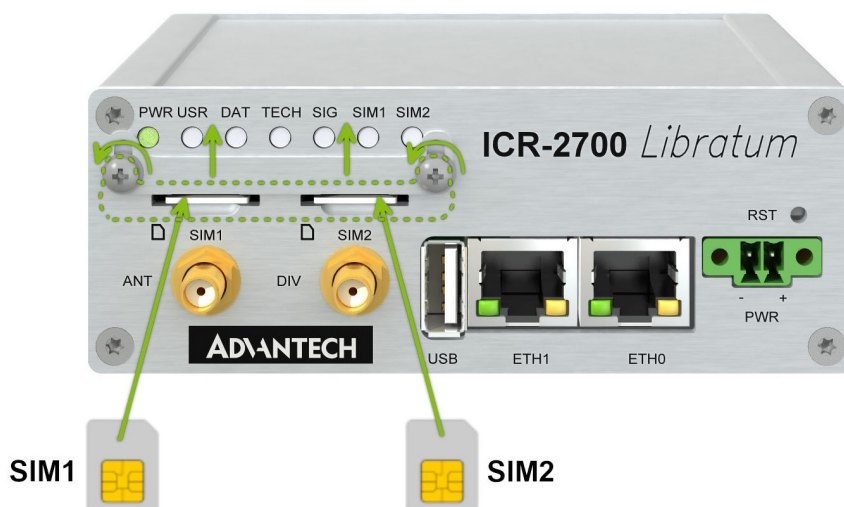

Figure 11: SIM Cards Insertion

2.2 Antennas

Connect cellular antennas to the router to main (ANT) and diversity (DIV) SMA connectors on the front panel.



Only run the router with a cellular antenna connected to the main antenna connector, as the energy from the transmission is effectively reflected by the open end and can damage the equipment.



Recommended tightening moment for screwing the antenna to the SMA connectors is 0.9 Nm.



The diversity antenna improves the radio capability of the router at low signal strength.

2.3 Ethernet Interfaces

The panel socket of RJ45 is used for Ethernet interface. The pinout of the socket is shown in Figure 12 and described in Table 5.

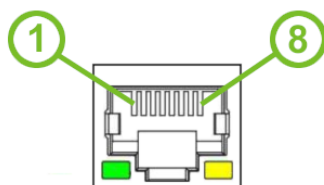

Figure 12: Ethernet Connector Pinout

Pin	Signal mark	Description
1	Tx+	Transmit Data+ (positive pole)
2	Tx-	Transmit Data- (negative pole)
3	Rx+	Receive Data+ (positive pole)
4	—	—
5	—	—
6	Rx-	Receive Data- (negative pole)
7	—	—
8	—	—

Table 5: Ethernet Connector Pinout Description



The isolation barrier of the Ethernet ports against the ground is 1500 V.

2.4 Power Supply

The pins of power supply are physically connected to the 6-pin terminal block panel socket located on the left panel. The connection of power supply is shown in Figure 13 and described in Table 6.

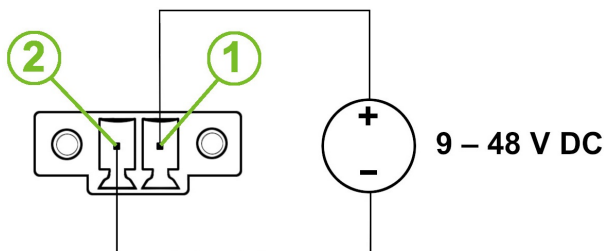

Figure 13: Connection of Power Supply

Pin	Signal mark	Description
1	PWR(+)	Positive pole of DC supply voltage (+9 to +48 V DC)
2	PWR(-)	Negative pole of DC supply voltage

Table 6: Power Supply Pinout

Required power supply voltage for the router is between +9 V and +48 V DC, see the connection scheme on Figure 13. Protection against reversed polarity without signaling is built into the router. For correct operation it is necessary that the power source is able to supply a peak current of 1 A.



Unit has to be supplied by a power supply specified as a Limited Power Source (LPS) or CEC/NEC Class 2 source of supply.

All metal parts of the router in a metal box, including the box itself, are connected with the negative pole of the power supply (common pole). If recommended for the installation environment, protect the router by grounding it properly by the grounding screw, see Figure 14.

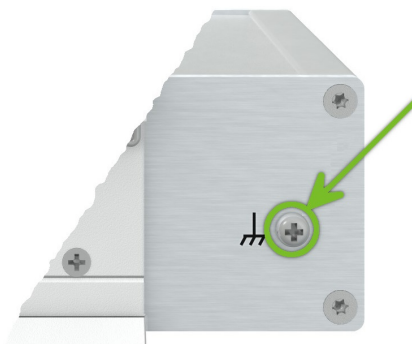

Figure 14: Position of the Grounding Screw

2.5 Low Power Mode



In applications requiring low power consumption (such as solar power - not 7/24 mode) is strictly recommended to use LPM mode prior to powering down the entire router.

LPM (Low Power Mode) is a router mode where the router is in sleep mode with minimal power consumption; see Chapter 4.1 for the LPM consumption. The router can be woken up from this mode after a predetermined period of time. Putting the router into LPM mode can be done using the `lpm` command, see [Commands and Scripts](#) application note for more details.

2.6 USB Port

There is one USB 2.0 host port with socket of USB-A type. USB Mass Storages and FTDI serial converters are supported. For a piece of advice, how to fix an unsupported FTDI chip, see the [Commands and Scripts](#) application note, chapter *How to Use Unsupported FTDI Chip*.



The USB port is disabled on overload to prevent its damage (connected device is trying to get too high current). The port is enabled again after the reboot of the router.

Mounting USB Flash Drive to the System

It is necessary to mount the USB flash drive to be able to access it in the system of the router. Follow these steps to mount the drive:

- Use the `dmesg` command to see the list of recently connected devices.
- In the output of the command find out the entry for the microSD card, for example:
`sda: sda1`
- To mount the card to `mnt` directory, use the `mount` command:
`mount /dev/sda1 /mnt`



For more information about the commands for creating, mounting, checking and unmounting a file system on a USB Flash Drive, see the application note for [Ext4_tools](#) router app.

USB Socket Pinouts

USB socket pinouts is described in Figure 15 and Table 7.

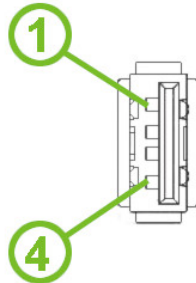

Figure 15: USB Connector Pinout

Pin	Signal mark	Description	Data flow direction
1	+5 V	Positive pole of 5 V DC supply voltage, 0.5 A	
2	USB data -	USB data signal – negative pole	Input/Output
3	USB data +	USB data signal – positive pole	Input/Output
4	GND	Negative pole of DC supply voltage	

Table 7: USB Connector Pinout

2.7 LED Status Indication

There are LED indicators on the front panel of the router to provide router status information. Moreover, ETH connector, has two additional LEDs providing information about the port status.

Caption	Color	State	Description
PWR	Green	On	The router is booting up.
	Green	Blinking	The router booted up and is ready.
	Green	Fast blinking	The router firmware is being updated.
USR	Green	—	The function of this LED is user-defined.
DAT	Green	Blinking	Cellular communication is in progress.
TECH	Green	On	The active SIM uses 4G technology.
	Orange	Blinking	The active SIM uses 3G technology.
	Red	Fast blinking	The active SIM uses 2G technology.
SIG	Green	On	Good cellular signal.
	Orange	Blinking	Fair cellular signal.
	Red	Fast blinking	Poor cellular signal.
SIM1	Green	On	SIM1 is active for the cellular connection.
	Red	Fast blinking	A SIM1 issue (missing card or PIN not entered).
SIM2	Green	On	SIM2 is active for the cellular connection.
	Red	Fast blinking	A SIM1 issue (missing card or PIN not entered).
ETH0	Green	On	Selected 100 Mbps bit rate.
ETH1	Green	Off	Selected 10 Mbps bit rate.
ETH0 ETH1	Orange	On	The network cable is connected.
	Orange	Blinking	Data transmission.
	Orange	Off	The network cable is not connected.

Table 8: LED Status Indication

2.8 Reset Functions



Consider creating a router configuration backup before performing the router's factory reset.

The *RST* button can be used in three different scenarios:

- **Reset:** Hold the *RST* button for **less than 4 seconds**; the router will reboot, applying its customized configuration. The router reset can be initiated by clicking the *Reboot* menu item in the router web GUI.
- **Factory Reset:** To restore the default factory configuration of the router, press and hold the *RST* button for **more than 4 seconds**. After that, the *PWR* LED turns off and on again. We recommend holding the *RST* button for 1 second after turning on the *PWR* LED.
- **Emergency Factory Reset:** If the router cannot boot up due to the incorrect configuration, turn off the router (disconnect the power supply). Then, push and hold the *RST* button, turn on the router and hold the *RST* button for **at least 10 seconds**. The router configuration will be set to the default one.



It is necessary to use a narrow screwdriver or any other small tool to press the *RST* button.



Figure 16: Resetting the Router

3. First Use

3.1 Accessories Connection

Before putting the router into operation, it is necessary to connect all the components required to run your applications; see Chapter 1.3 for the hardware overview. Remember to insert a SIM card for the cellular connection; see Chapter 2.1.



Do not run the router without antenna connected to the main antenna connector as the energy from the transmission is effectively reflected by the open end and can damage the equipment.

3.2 Router Configuration

Initial router configuration can be made via a web browser on your PC. Here you can perform router monitoring, configuration, and administration.

Connect the power supply to the router, see Chapter 2.4, and the router will boot up. By default, the router will automatically log on to the default APN of the inserted SIM card. Configure your PC to get the IP settings automatically from the network. Connect the network card of your PC to the default router LAN interface, Ethernet port ETH0, and the DHCP server will assign an IP address to your PC.

To get the router web interface, enter the <https://192.168.1.1> address in a web browser. Please note that usage of the HTTPS protocol for secure communication over the network is required.

There is just the `root` **user account** created on the router by default. See the **product label** on the router for its **default password**¹. Log in to the web interface with the `root` user and his password. If logged in successfully, the user will have access to the router web interface, see Figure 17. See the router configuration manual [1] for a detailed description and examples of the router configuration.



After logging on to the device for the first time, we strongly recommend changing the default password due to security reasons.



For security reasons, we recommend regularly updating the router's firmware to the latest version. Downgrading the firmware to an older version than the production version or uploading firmware intended for a different device may cause the device's malfunction.



All routers have the *WebAccess/DMP* client pre-installed by default. The activated client periodically uploads router identifiers and configuration to the *WebAccess/DMP* server. See the configuration manual [1], chapter *Basic Information -> WebAccess/DMP Configuration*, for more information.

¹Use the password `root` if the router's label does not contain a unique password.

ICR-2734 LTE Router

Name: N/A
Location: N/A

Status	General Status
<ul style="list-style-type: none"> General Mobile WAN Network DHCP IPsec WireGuard DynDNS System Log 	<div style="background-color: #e6f2ff; padding: 5px; margin-bottom: 5px;"> <p style="text-align: center; margin: 0;">Mobile Connection</p> <p>SIM Card : 1st IP Address : 10.80.0.65 IPv6 Address : Unassigned Rx Data : 588 B Tx Data : 846 B Uptime : 0 days, 9 hours, 5 minutes</p> <p style="text-align: right; font-size: small;">» More Information «</p> </div> <div style="background-color: #e6f2ff; padding: 5px; margin-bottom: 5px;"> <p style="text-align: center; margin: 0;">ETH0</p> <p>IP Address : 10.64.0.121 / 255.255.252.0 IPv6 Address : fd00:a41:121 / 56 MAC Address : 02:AD:FF:00:01:21 Rx Data : 173.7 KB Tx Data : 39.3 KB</p> <p style="text-align: right; font-size: small;">» More Information «</p> </div> <div style="background-color: #e6f2ff; padding: 5px; margin-bottom: 5px;"> <p style="text-align: center; margin: 0;">ETH1</p> <p>IP Address : 10.65.0.121 / 255.255.252.0 IPv6 Address : fd00:a41:121 / 56 MAC Address : 02:AD:FF:01:01:21 Rx Data : 6.6 KB Tx Data : 680 B</p> <p style="text-align: right; font-size: small;">» More Information «</p> </div> <div style="background-color: #e6f2ff; padding: 5px;"> <p style="text-align: center; margin: 0;">System Information</p> <p>Firmware Version : 6.3.4 (2022-01-04) BETA #1506 Serial Number : ACZ1199000001213 Hardware UUID : N/A Profile : Standard Supply Voltage : 24.1 V Temperature : 49 °C Time : 2022-01-06 10:20:38 Uptime : 0 days, 9 hours, 5 minutes</p> <p style="text-align: right; font-size: small;">» Licenses «</p> </div>
<p>Configuration</p> <ul style="list-style-type: none"> Ethernet VRPP Mobile WAN PPPoE Backup Routes Static Routes Firewall NAT OpenVPN IPsec WireGuard GRE L2TP PPTP Services USB Port Scripts Automatic Update 	
<p>Customization</p> <ul style="list-style-type: none"> Router Apps 	
<p>Administration</p> <ul style="list-style-type: none"> Users Change Profile <li style="color: red;">Change Password Set Real Time Clock Set SMS Service Center Unlock SIM Card Unblock SIM Card Send SMS Backup Configuration Restore Configuration Update Firmware Reboot Logout 	

Figure 17: Router's Web Interface



A detailed description of the router settings in the web interface can be found in the configuration manual [1] of the router.

4. Technical Specifications

4.1 Basic Parameters

Parameter		Description
Temperature range	Operating	-40 °C to +75 °C
	Storage	-40 °C to +85 °C
Humidity	Operating	5 to 95 % relative humidity non condensing
	Storage	5 to 95 % relative humidity non condensing
Altitude	Operating	2000 m / 70 kPa
Degree of protection		IP30
Supply voltage		9 to 48 V DC
Battery for RTC		CR1225
Consumption	Idle	1.6 W
	Average	3 W
	Maximum	6.9 W
	LPM mode	5 mW
Dimensions of device w/o clip		113,2 × 80,3 × 42 mm (metal box) 117 × 83,8 × 51,4 mm (plastic box)
DIN rail clip specification		DIN 35 mm, EN 60715
Weight		260 g (metal box) 200 g (plastic box)
Antenna connectors	ANT, DIV	SMA connectors for LTE – 50 Ω
Interfaces	ETH0	RJ-45 socket for 10/100 Mbps Ethernet
	ETH1	RJ-45 socket for 10/100 Mbps Ethernet
	USB	USB-A socket

Table 9: Basic Parameters

4.2 Standards and Regulations

The router complies with the following standards and regulations:

Parameter	Description
Radio	EN 301 511, EN 301 908-1, EN 301 908-2, EN 301 908-13
EMC	EN 301 489-1, EN 301 489-52, EN 61000-4-2, EN 61000-4-3, EN 61000-4-4, EN 61000-4-5, EN 61000-4-6, EN 61000-4-11, EN 61000-6-2, EN 61000-6-3, EN 55032
Safety	IEC 62368-1, IEEE 802.3
Transportation	E-Mark (E8), homologation number: 10R-06 13493
National	CE, UKCA compliant
Environmental	REACH, RoHS3 and WEEE compliant

Table 10: Standards and Regulations

4.3 Type Tests and Environmental Conditions

Phenomena	Test	Description	Test levels
ESD	EN 61000-4-2	Enclosure	CD ± 6 kV, L3 AD ± 8 kV, L3
RF field AM modulated	EN 61000-4-3	Enclosure	20 V/m, 80 MHz – 1 GHz, LX 10 V/m, 1 GHz – 6 GHz, L3
Fast transient	EN 61000-4-4	DC ETH - FTP AC/DC	± 1 kV, 5/50Tr/Th ns, 100 kHz, L2 ± 1 kV, 5/50Tr/Th ns, 100 kHz, L3 ± 2 kV, 5/50Tr/Th ns, 100 kHz, L3
Surge	EN 61000-4-5	DC ETH AC/DC	± 1 kV, 1,2/50(8/20) Tr/Th us L2 ± 1 kV, 1,2/50(8/20) Tr/Th us L2 ± 2 kV, 1,2/50(8/20) Tr/Th us L3
RF conducted	EN 61000-4-6	DC ETH AC/DC	10V,0.15-80MHz,80% AM(1kHz),L3 10V,0.15-80MHz,80% AM(1kHz),L3 10V,0.15-80MHz,80% AM(1kHz),L3
Dips & interruptions	EN 61000-4-11	AC/DC	dip 0% 0,5cycle, 0% 1 cycle, 70% 25 cycles, interruption 0% 250 cycles
Radiated emission	EN 55032	Enclosure DC ETH AC/DC	Cl. B,30MHz-1GHz,1GHz-6GHz Class B, 150 kHz – 30 MHz Class B, 150 kHz – 30 MHz Class B, 150 kHz – 30 MHz

Table 11: Type Tests and Environmental Conditions

4.4 Parameters of Cellular Module

Parameter	Description
Antenna	Connector type: SMA Impedance: 50 Ω
LTE parameters	LTE: LTE Cat.4, 3GPP Rel. 10 FDD frequencies: B28 (700 MHz), B20 (800 MHz), B5 (850 MHz), B8 (900 MHz), B3 (1800 MHz), B1 (2100 MHz), B7 (2600 MHz) Bit rates: up to 150 Mbps (DL), 50 Mbps (UL)
HSPA+/UMTS parameters	HSPA: 3GPP Release 7 UMTS: 3GPP Release 4 Supported frequencies: B8 (900 MHz), B3 (1800 MHz), B1 (2100 MHz) Bit rates: max. 21 Mbps (DL) / 5.7 Mbps (UL)
EDGE/GPRS parameters	Supported frequencies: B5 (850 MHz), B8 (900 MHz), B3 (1800 MHz), B2 (1900 MHz) Bit rates: max. 237 kbps (DL) / 237 kbps (UL)

Table 12: Technical Parameters of Cellular Module

4.5 System Configuration

The main parameters of the system are listed in Table 13.

Parameter	Description
CPU architecture	ARM926EJ-S
CPU frequency	600 MHz
CPU power	4,72 DMIPS/MHz
Flash memory	4 MB of NOR 4 096 MB of eMMC <ul style="list-style-type: none"> • 838 MB for Router Apps • 512 MB for customer data
RAM size	128 MB
Watchdog	HW Watchdog
RTC	Battery Backup RTC
TPM ¹	Trusted Platform Module (TPM) 2.0

Table 13: System Configuration

¹Not assembled by default, for a dedicated customer order only.

Appendix A: Troubleshooting

If you cannot connect to the router from your PC, your network card may be configured in such a way that it is not possible to connect to the router. Take one or more of the following steps in order to solve the problem:



- Make sure your PC's network card is configured to obtain the IP address from the DHCP server (by default the DHCP server is running in the router).
- Connect the router to the PC via Switch.
- Connect the router to the PC, start the router first and then start the PC after the router's initialization.

Ethernet connection fails or is not establishing.

- *It is possible to turn auto negotiation off and set a rate and duplex manually on the Ethernet interface of the router. Available on "LAN Configuration" page in the router.*

Mobile WAN connection fails.

- *Check the signal power ("Mobile WAN status" page). If the signal power is weak, you will have to use a better antenna. If the neighbouring cells have a similar signal strength, you will need to use a directional antenna. For proper operation, the signal levels have to be good.*
- *Try to enable automatic ping from the router, which will check the connection when there are no data running and in the case of a failed ping, restart the connection. This can be done on the "Mobile WAN Configuration" page in the router in the "Check connection" section. "Enable + bind" option is to ensure the ping goes always through Mobile WAN network interface.*

Mobile WAN connection cannot be established.

- *Check the "Mobile WAN Configuration" – APN, name, password and IP address (all can be blank).*
- *Try to enter the SIM card PIN – verify that the SIM card has the PIN code entered. Available on "Unlock SIM Card" page in the "Administration" section.*
- *In a private APN it is not recommended to get the DNS settings from operator (on "Mobile WAN" page)*
- *Go to "System Log" page in "Status" section and observe where the error occurs.*

I cannot connect from the Internet to the device behind the router. I have NAT enabled.

- *The device's gateway has to be configured so it points to the router.*

 **I can't access my Web server placed behind the router over NAT.**

- *The remote HTTP access to the router has to be disabled on "NAT Configuration" page in the router. Also enable "Send all remaining incoming packets to default server" feature and fill in the IP address of your Web server. On the Web server, the default gateway has to be the IP address of the router.*

 **DynDNS doesn't work.**

- *With private APN this will not work.*
- *If the same IP address is recorded in your canonic name as a dynamically assigned address, it means that the operator is using NAT or a firewall.*
- *You can verify NAT using ping to your server with static address and then compare with router's IP address.*
- *You can verify a Firewall by accessing remotely to the router's Web interface.*
- *The operator may not provide the address of DNS server and without DNS server's address it is impossible to connect to the dyndns.org server. The following messages will be shown in the System Log:*
 - *DynDNS daemon started*
 - *Error resolving hostname: no such file or directory*
 - *Connect to DynDNS server failed*

 **L2TP or IPSec isn't establishing.**

- *Check the "System Log" page for error messages.*

 **IPSec tunnel establishes but the communication does not run.**

- *Probably there are bad routing rules defined in the connected devices, or the default gateway.*

 **I switched the router to offline mode by SMS message, but the router is in online mode after reboot.**

- *SMS messages do not change the router configuration. They remain in effect only until the router is rebooted.*

Serial communication is not working.

- *Verify that the router model supports serial communications. Also verify the serial communication settings. To do so, open the router's configuration menu via the web browser, select the appropriate "Expansion Port" from "Configuration" part of the menu and verify the settings.*

Is the router Cisco compatible? Can I use the Cisco configuration?

- *No, the Firmware in the router (Conel OS) is based on Linux with BusyBox. Thus the Cisco configuration cannot be used. But network connections are defined by standards so connecting the router to the Cisco or other networking devices is possible and will be compatible.*

FTP or SFTP does not work

- *FTP will work on v2 routers only. You can use SFTP on all routers to transfer files to/from the router. If having troubles with FTP on v2 routers, make sure you have FTP enabled: "Configuration" section, "Services", "FTP". Then you can connect with any client on port 21 with name and password same as for the Web interface. If having troubles with SFTP, make sure you have SSH enabled: "Configuration" section, "Services", "SSH". Then you can connect with any client on port 22 with name and password same as for the Web interface.*

How can I connect to the router's command line? (SSH, Telnet)

- *You can use SSH on all routers or Telnet on v2 routers only. SSH is enabled by default, but you can verify in Web interface in "Configuration" section, "Services", "SSH". Then connect with any SSH client on port 22 of the router. User and password is the same as for the Web interface. Telnet on v2 routers can be enabled here: "Configuration" section, "Services", "Telnet".*

Appendix B: Customer Support

Customer Support for Europe

Advantech Czech s.r.o.

Sokolska 71
562 04, Usti nad Orlici
Czech Republic

Phone: +353 91 792444
Fax: +353 91 792445
E-mail: iiotcustomerservice@advantech.eu
Web: www.advantech.com

Customer Support for NAM

Advantech B+B SmartWorx

707 Dayton Road
Ottawa, IL 61350 USA

Phone: +1-800-346-3119 (Monday – Friday, 7 a.m. to 5:30 p.m. CST)
Fax: +1-815-433-5109
E-mail: support@advantech-bb.com
Web: www.advantech-bb.com

Customer Support for Asia

Phone: +886-2-2792-7818 #1299 (Monday – Friday, 9 a.m. to 5:30 p.m. UTC+8)
Fax: +886-2-2794-7327
E-mail: icg.support@advantech.com.tw
Web: www.advantech.com

Appendix C: Regulatory & Safety Information

Safety Notices



Please, observe the following instructions:

- The router must be used in compliance with all applicable international and national laws and in compliance with any special restrictions regulating the utilization of the router in prescribed applications and environments.
- To prevent possible injury and damage to appliances and to ensure compliance with all relevant provisions, use only the original accessories. Unauthorized modifications or the use of unapproved accessories may result in damage to the router and/or a breach of applicable regulations. Unauthorized modifications or use of unapproved accessories may void the warranty.
- The router can not be opened.
- Turn off the router and disconnect it from power supply before handling the SIM card.
- **Caution!** This equipment is not suitable for use in locations where children are likely to be present. The SIM card could be swallowed by small children.
- Power supply must not exceed 48 V DC max.
- Do not expose the router to extreme ambient conditions. Protect the router against dust, moisture and high temperature.
- Only routers with appropriate certification and labelling should be used in locations where flammable and explosive materials are present, including gas stations, chemical plants, or locations in which explosives are used. We remind users of the duty to observe the restrictions concerning the utilization of radio devices at such places.
- Switch off the router when travelling by plane. Utilization of the router on a plane may endanger the operation of the plane or interfere with the mobile telephone network, and may be unlawful. Failure to observe these instructions may result in the suspension or cancellation of telephone services for the respective client and/or may result in legal sanctions.
- When using the router in close proximity to personal medical devices, such as cardiac pacemakers or hearing aids, you must proceed with heightened caution.
- The router may cause interference when used in close proximity to TV sets, radio receivers or personal computers.
- It is recommended that you create an appropriate copy or backup of all important settings that are stored in the memory of the device.



Product Disposal Instructions

The WEEE (Waste Electrical and Electronic Equipment: 2012/19/EU) directive was introduced to ensure that electrical/electronic products are recycled using the best available recovery techniques to minimize the environmental impact. This product contains high quality materials and components which can be recycled. At the end of its life this product MUST NOT be mixed with other commercial waste for disposal. The device contains a battery. Remove the battery from the device before disposal. The battery in the device needs to be disposed of apart accordingly. Check the terms and conditions of your supplier for disposal information.

Appendix D: Related Documents

[1] [Configuration Manual for v2i Platform](#)



[EP] Product-related documents and applications can be obtained on **Engineering Portal** at <https://icr.advantech.cz/download> address.



We, Advantech Czech s.r.o., declare that the radio equipment narrated in this user's manual complies with Directive **2014/53/EU**.



We, Advantech Czech s.r.o., declare that the radio equipment narrated in this user's manual complies with Radio Equipment Regulations 2017 (**S.I. 2017 No. 1206**).

The full text of the EU Declaration of Conformity is available at the following internet address:
icr.advantech.cz/eudoc